

MPS/MST

SERIES

S PIN - ON FILTER SUCTION - RETURN



Maximum working pressure 12 bar

Flow rates to 300 l/min

MPFILTRI
filtri per oleodinamica



Description

MPS / MST

The **MPS** spin-on filter series is a complete product range suitable, for both suction and return applications. Utilising spin-on canisters, the MPS series are quick and easy to service and provide a 'clean' solution when changing elements.

The filter elements are either resin-impregnated paper ($\beta_{x>2}$), glass fibre ($\beta_{x\geq 200}$) or square wire mesh.

The unique filter head is designed for both European CS and American CG standard canister series. One head design series accommodates both styles of elements.

Also available is a new design utilizing a pressure differential visual and electrical indicators - ideal for lubrication applications.

MPS filters are specifically designed for contamination control in hydraulic and lubrication circuits for mobile applications, agricultural and machine tool systems.

The **CW** series of canister removes water from oil while filtering the oil at the same time.

Water absorbent polymers up to 800 times their own weight, provide this major feature.

Water holding capacities: - CW 050 - 240 ml.
CW 150 - 788 ml.

DIFFERENTIAL INDICATORS For Use with series "1" filter heads.



New

absolute filter elements
independently tested
in the following Institutes:

Institute of Filtration
(France)



For Use with series "0" filter head.

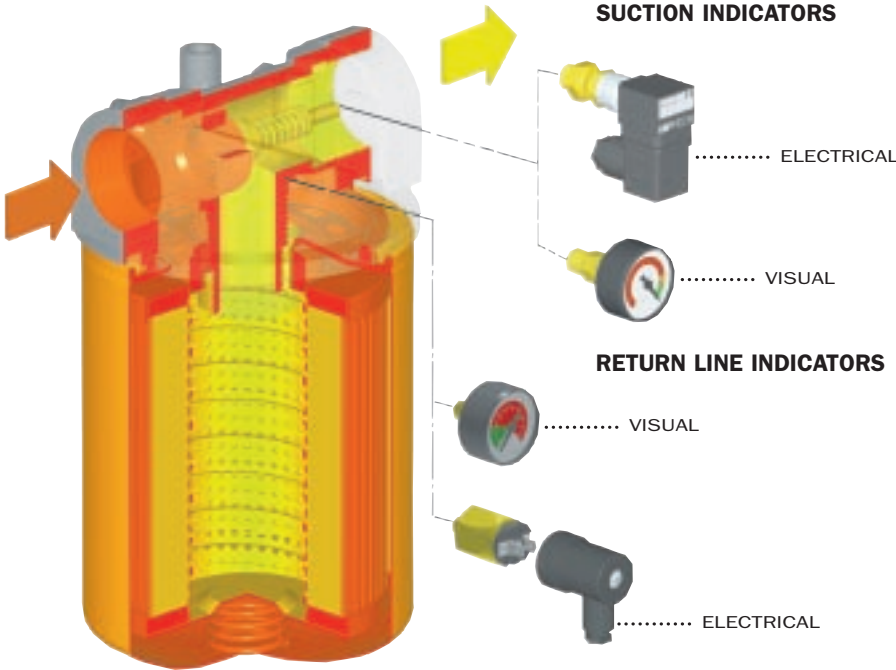

Filter element:

Materials

End caps:
Galvanized steel

Support tube:
Galvanized steel

Support frames:
Galvanized steel with an epoxy coating

A Series

Inorganic microfibre

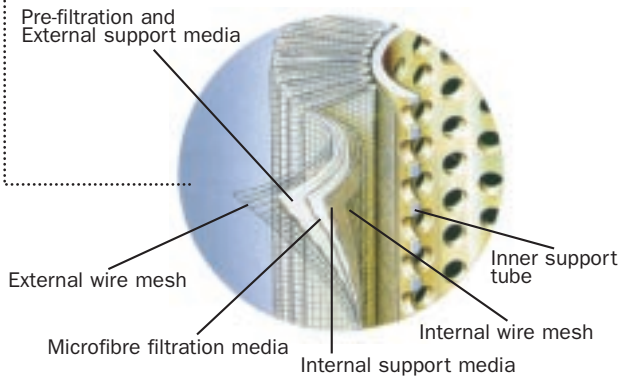

MP Filter elements - Conform to the following ISO standards

- ISO 2941 - Verification of collapse/burst resistance.
- ISO 2942 - Verification of fabrication integrity and determination of the first bubble point.
- ISO 2943 - Verification of material compatibility with fluids.
- ISO 3723 - Method for end load test.
- ISO 3724 - Verification of flow fatigue characteristics.
- ISO 3968 - Evaluation of pressure drop versus flow characteristics.
- ISO 16889 - Multi-pass method for evaluating filtration performance.

Element material Absolute filtration

A Series

Inorganic microfibre with acrylic support

Contamination retention

as per ISO 16889: Multi-pass test.

New improved $\beta \geq 200$ filter elements with greater efficiency and increased dirt holding capacity

Filter elements	Dimensions for β (μm) values				Filtration ratios			ΔP (bar)
	$\beta \geq 2$ (50%)	$\beta \geq 20$ (95%)	$\beta \geq 75$ (98,7%)	$\beta \geq 200$ (99,5%)	β_2	β_{10}	β_{20}	
A03	-	2	2,4	3	20	> 10.000	> 10.000	7
A06	-	3	4,6	6	8	> 2.000	> 10.000	7
A10	3	6	7,8	10	1,5	≥ 200	> 10.000	7
A25	13	19	22	25	-	> 1,5	> 35	7

N.B. Other materials giving different degrees of filtration are available on request.

Type	050	070	100	150
CS-CG-CT				
A03/A06	1900	3160	3950	5390
A10/A25	1900	3160	3950	5390

Values in cm^2

Filtering area Filter elements

Element material Nominal filtration

P Series

Resin - impregnated paper

M Series

Square wire mesh (filtration degree is defined in microns by the maximum diameter of a sphere corresponding to the mesh size)

Filtering area Filter elements

Type	050	070	100	150
CS-CG-CT				
P10/P25	2440	4140	4300	5760
M25	1000	1270	1990	2400
M60	1000	1270	1990	2400
M90	1000	1270	1990	2400

Values in cm^2

CW Series

Resin - impregnated paper

Type CW	050	150
P10/P25	2000	3050

Materials

Head

Aluminium

Bypass valve

Nylon

Seals

A Series: Nitrile (Buna-N)

V Series: Viton

Indicator

Brass

Working

temperature

From -25 to +110°C

For temperatures outside this range, please consult our Sales Network Organization

Pressure filter

body

Maximum working pressure up to

12 bar

Collapse pressure

filter elements

4 bar

Bypass valve

Calibration pressure

Bypass valve, differential opening pressure:

S series: 0,3 bar ± 10% (MPS series only)
R series: 1,75 bar ± 10%

Types of indicators for MPS series "0" (MPS 050-070-100...) and MST series

Description:

MPS series filters are fitted with indicators

switching:

Suction filters at a pressure of:

Line filters at a pressure of:

Return filter at a pressure of:

1 Kpa = 0.01 bar

20 kPa ± 10%

1,3 bar ± 10% (MPS series only)

1,3 bar ± 10% (MPS-MST series only)

Visual indicator

Suction filter: (MPS series only)

VS vacuum switch

scale 0 - 76 cm Hg

Return and line filter

VA Pressure gauge

VR colour coded pressure gauge

scale 0 - 12 bar

scale 0 - 6 bar

Electrical indicator

Suction filter (MPS series only)

E0 Vacuum switch with change over contact

Return filter

ER Pressure switch with N.O. contacts

EC Pressure switch with N.C. contacts

Operational information:

Switching at 20kPa ± 10%

Max voltage: 250V 50÷60 Hz

Max current: 5 A resistive, 2 A inductive

Protection degree IP65

Switching at 1,3 bar ± 10%

Max voltage: 48V 50÷60 Hz

Max current: 0,5A resistive

0,2A inductive

Types of indicators for MPS series "1" (MPS 051-071-101-151-301-351)

MPS filter series 1 (051-071-101... and so on) are fitted with, differential style indicators.

Visual indicator

1V - Z1 Series for Filter with bypass set to 1,75 bar

switching at 1,2 bar ± 10%

Electrical indicator

V6 - Z6 Series for Filter without bypass

switching at 2 bar ± 10%

Visual-electrical indicator

N1 Series for Filter with bypass set to 1,75 bar

switching at 1,2 bar ± 10%

N6 Series for Filter without bypass

switching at 2 bar ± 10%

1E - K1* Series for Filter with bypass set to 1,75 bar

switching at 1,2 bar ± 10%

E6 - K6* Series for Filter without bypass

switching at 2 bar ± 10%

*For K visual-electrical indicator, specify the voltage (il. K61 = LED: 24 volt)

* { 1 - 24 Volt
2 - 115 Volt
3 - 230 Volt

MP Filtri - Specification

Pressure differential indicator option

K - E - N Series

Supply voltage (50/60 Hz) (V)	Resistive load (A)	Inductive load (A)
Vca 125	5	2
Vca 250	5	2
Vcc 30	5	3
Vcc 125	0,5	0,03
Vcc 250	0,25	0,03

CONNECTOR DIN 43650

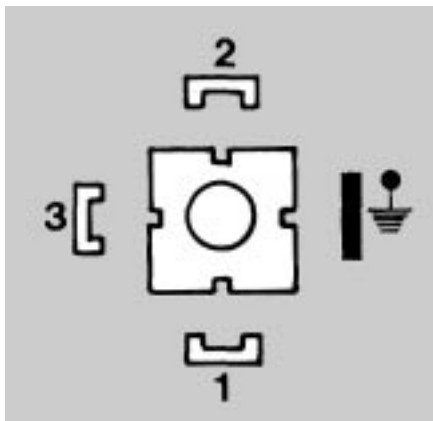

ELECTRICAL CONNECTION E - N SERIES

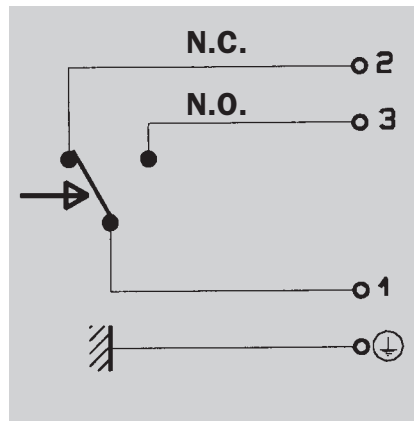

ELECTRICAL CONNECTION K SERIES

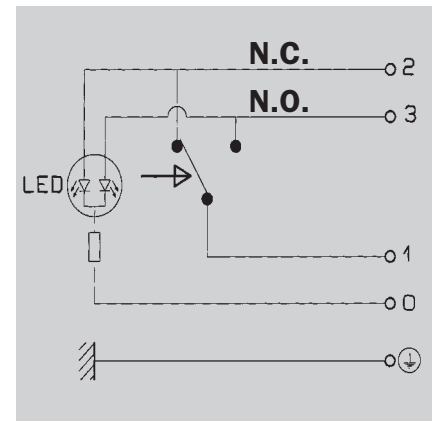

Visual V series

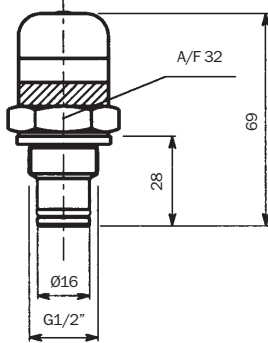

Visual Z series

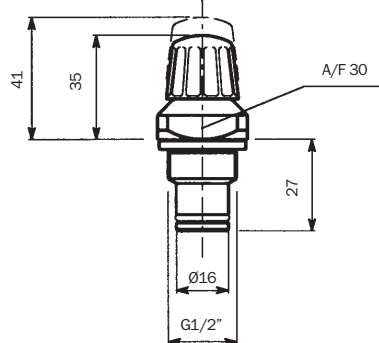

Electrical N series

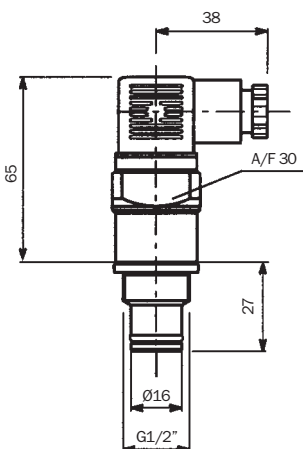

Visual led - Electrical K series

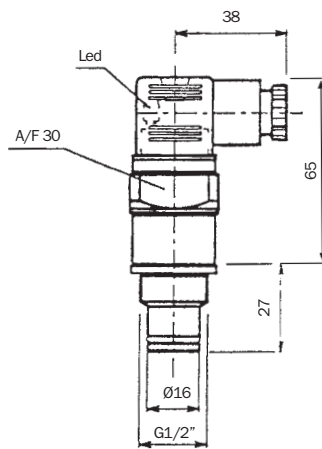

Visual - Electrical E series

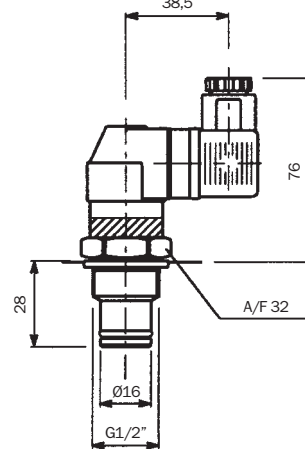

Fluid

Compatibility

Filter head and bowls

compatible for use with:

- mineral oils
(types HH-HL-HM-HR-HV-HG as per ISO 6743/4)
- water-based emulsions
(types HFAE-HFAS as per ISO 6743/4)
- synthetic fluids
(types HS-HFDR-HFDS-HFDU as per ISO 6743/4)
- water-glycol (types HFC as per ISO 6743/4)

Seals

A Series

Nitrile (Buna-N) compatible with mineral oils
(types HH-HL-HM-HR-HV-HG as per ISO 6743/4)

water-based emulsions

(types HFAE-HFAS as per ISO 6743/4)

water - glycol (types HFC as per ISO 6743/4)

V Series

Viton compatible with synthetic fluids

(types HS-HFDR-HFDS-HFDU as per ISO 6743/4)

Filter elements

As per ISO 2943; suitable for mineral oils
(types HH-HL-HM-HR-HV-HG as per ISO 6743/4)

and synthetic fluids (A and M series only)
(types HS-HFDR-HFDS-HFDU as per ISO 6743/4)

For water-based emulsions (types HFAE-HFAS
as per ISO 6743/4) and fluids other than
those mentioned, please consult our Sales
Network Organization.

International standards for contamination fluid control

A general (no direct) comparison between ISO 4406 and NAS 1638 is given in table below.

Contamination codes ISO 4406			Correspondent codes NAS 1638	Recommended filtration degree	Typical applications
<i>4µm(c)</i>	<i>6µm(c)</i>	<i>14µm(c)</i>		<i>B x ≥ 200</i>	
14	12	9	3	3	High precision and laboratory servo-systems
17	15	12	6	3-6	Robotic and servo-systems
18	16	13	7	10-12	Very sensitive - high reliability systems
20	18	15	9	12-15	Sensitive - reliable systems
21	19	16	10	15-25	General equipment of limited reliability
23	21	18	12	25-40	Low - pressure equipment not in continuous service

Selection & installation information

Filter elements types

A Series

Absolute inorganic microfibre filtration media, available in 3, 6, 10 and 25 micron
Example - **A03, A06, A10** or **A25**

P Series

Nominal cellulose impregnated paper media, available in 10 and 25 micron.
Example - **P10** or **P25**

M Series

Metal mesh media, available in 25, 60, and 90 micron.
Example - **M25, M60** or **M90**.

Please refer to individual pressure drop curves to obtain filter assembly pressure drop information

The following filter sizing recommendations are based using a mineral oil fluid at 30 mm²/s (cSt) with a maximum total filter assembly (housing and filter element) pressure drop of 30% of the filter condition indicator (0.4 bar) for line and return filter and 8 kPa for suction filter.

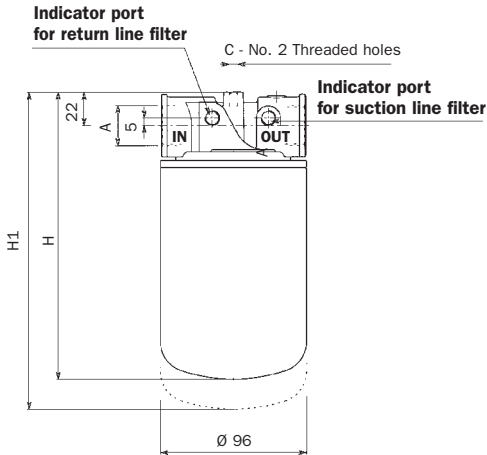

MPS 050-071

Lengths

Type	H	H1
050-051	180	200
070-071	248	268

MPS SERIES 050-051 SIZES

Filter assembly	Line Flow rate l/min *	Suction Flow rate l/min *	Port size BSP/NPT/SAE	Weight kg **
A03	40	9	SEE TABLE BELOW	1,0
A06	44	11		
A10	48	14		
A25	58	18		
P10	55	16		
M60-M90	-	24		

MPS SERIES 070-071 SIZES

Filter assembly	Line Flow rate l/min *	Suction Flow rate l/min *	Port size BSP/NPT/SAE	Weight kg **
A03	45	11	SEE TABLE BELOW	1,3
A06	49	13		
A10	53	15		
A25	63	20		
P10	58	18		
M60-M90	-	26		

* Flow rates with 30 mm²/s fluid viscosity

** Weight including filter element

MPS 050-070 Series

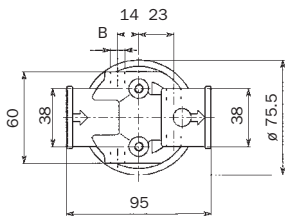

MPS 051-071 Series

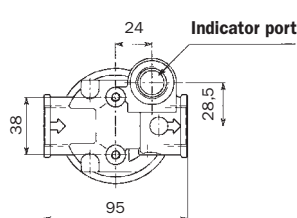

Indicator for suction filter MPS 050-070 (only for option G1-G5)

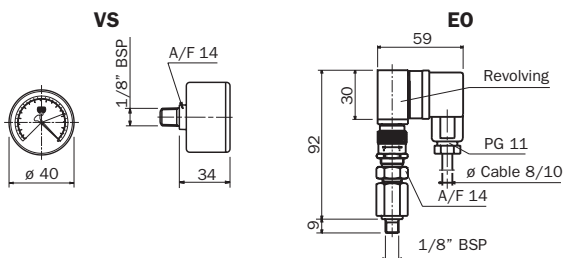

Thread connections

Type	A	B	C
G1	3/4" BSP	1/8" BSP	M6
G2	3/4" NPT	1/8" NPT	1/4" UNC
G3	SAE 12 - 1 1/16" - 12 UN	1/8" NPT	1/4" UNC
G4	SAE 8 - 3/4" - 16 UNF	1/8" NPT	1/4" UNC
G5	1" BSP	1/8" BSP	M6
G6	1" NPT	1/8" NPT	1/4" UNC

Indicator for return filter MPS 050-070 (only for option G1-G5)

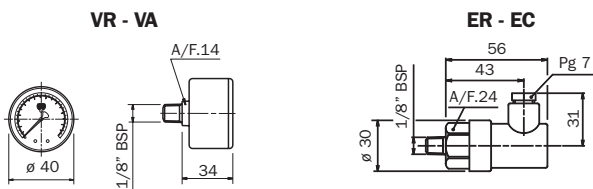

Indicator for line filter MPS 051-071

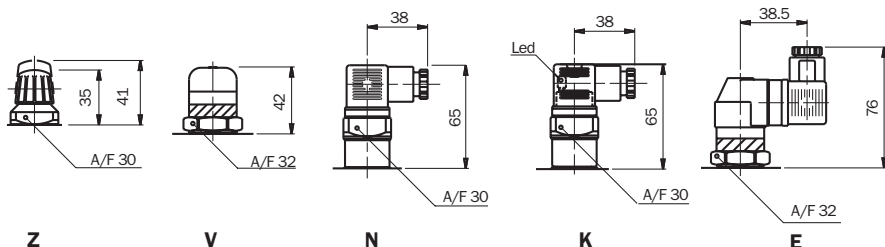

Suction filter - Housing pressure drop

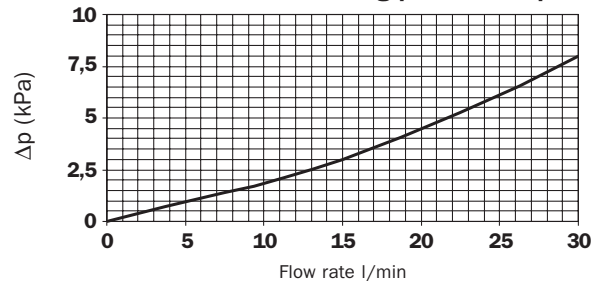

Return line filter - Housing pressure drop

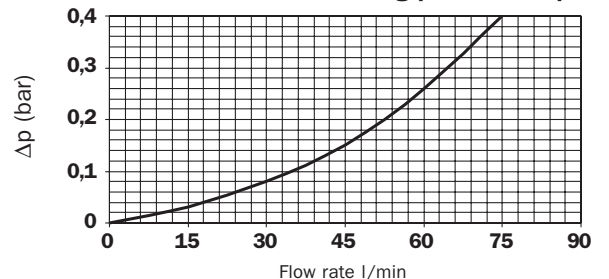

Selection & installation information

Please refer to individual pressure drop curves to obtain filter assembly pressure drop information

The following filter sizing recommendations are based using a mineral oil fluid at 30 mm²/s (cSt) with a maximum total filter assembly (housing and filter element) pressure drop of 30% of the filter condition indicator (0.4 bar) for line and return filter and 8 kPa for suction filter.

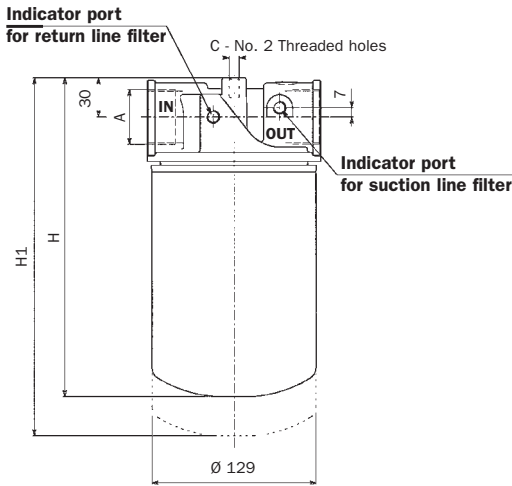

MPS 100-151

Lengths

Type	H	H1
100-101	241	266
150-151	286	311

MPS 100-150 Series

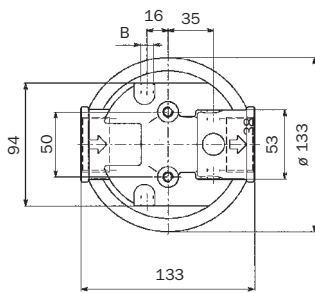

MPS 101-151 Series

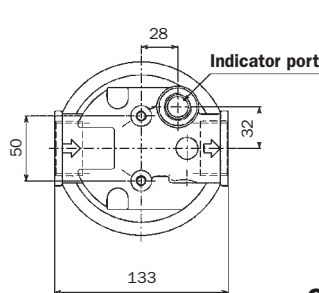

Indicator for suction filter MPS 100-150 (only for option G1)

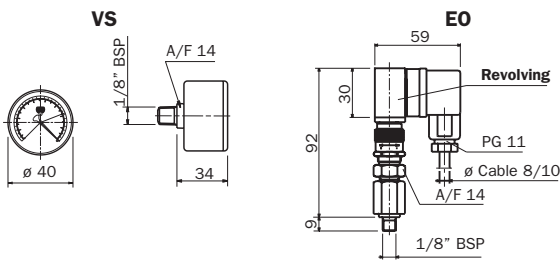

Indicator for return filter MPS 100-150 (only for option G1)

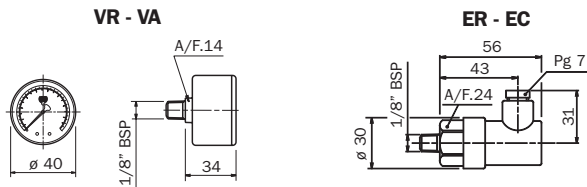

Indicator for line filter MPS 101-151

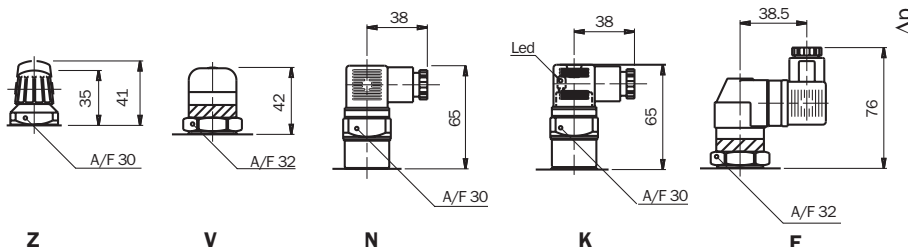

MPS SERIES 100-101 SIZES

Filter assembly	Line Flow rate l/min *	Suction Flow rate l/min *	Port size BSP/NPT/SAE	Weight kg **
A03	75	16	1 1/4"	2,2
A06	85	19		
A10	110	25		
A25	140	40		
P10	130	35		
M60-M90	-	65		

MPS SERIES 150-151 SIZES

Filter assembly	Line Flow rate l/min *	Suction Flow rate l/min *	Port size BSP/NPT/SAE	Weight kg **
A03	85	18	1 1/4"	2,3
A06	100	22		
A10	115	30		
A25	160	45		
P10	150	40		
M60-M90	-	68		

* Flow rates with 30 mm²/s fluid viscosity
** Weight including filter element

Thread connections

Type	A	B	C
G1	1 1/4" BSP	1/8" BSP	M8
G2	1 1/4" NPT	1/8" NPT	5/16" UNC
G3	SAE 20 - 1 5/8" - 12 UN	1/8" NPT	5/16" UNC

Suction filter - Housing pressure drop

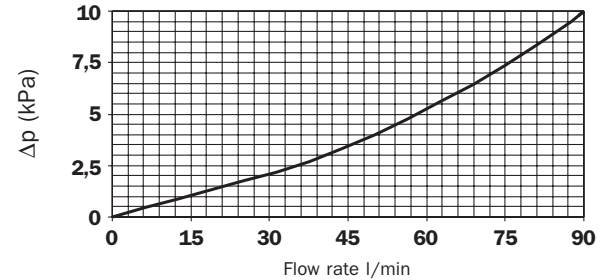

Return line filter - Housing pressure drop

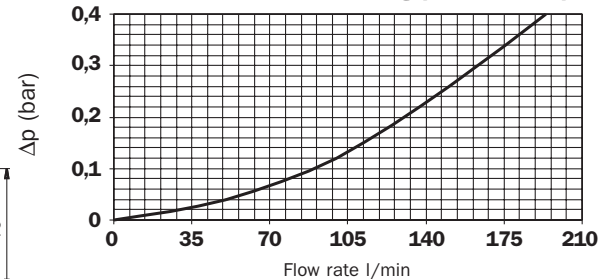

Selection & installation information

Please refer to individual pressure drop curves to obtain filter assembly pressure drop information

The following filter sizing recommendations are based using a mineral oil fluid at 30 mm²/s (cSt) with a maximum total filter assembly (housing and filter element) pressure drop of 30% of the filter condition indicator (0.4 bar) for line and return filter and 8 kPa for suction filter.

MPS 200-250

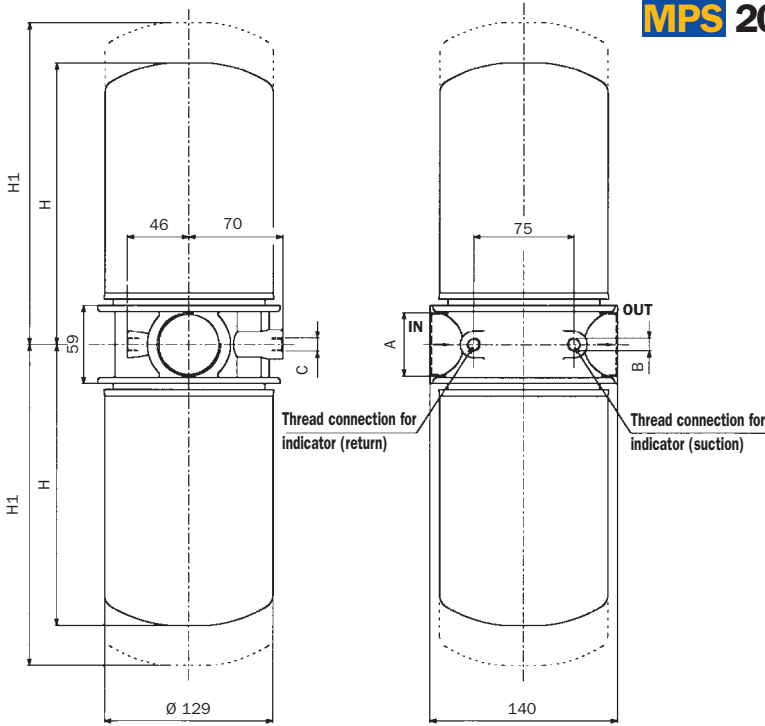

Lengths

Type	H	H1
200	216	241
250	261	286

Indicator for suction filter (only for option G1)

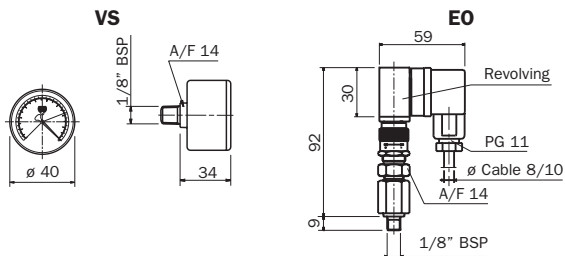

Indicator for return filter (only for option G1)

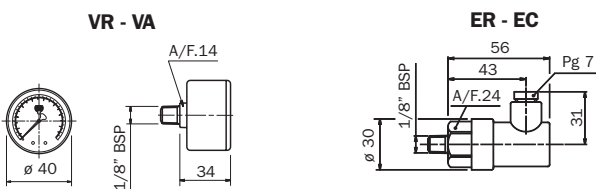

MPS SERIES 200 SIZES

Filter assembly	Line Flow rate l/min *	Suction Flow rate l/min *	Port size BSP/NPT/SAE	Weight kg **
A03	130	30	1 1/2"	4,0
A06	170	45		
A10	220	65		
A25	290	110		
P10	270	100		
M60-M90	-	120		

MPS SERIES 250 SIZES

Filter assembly	Line Flow rate l/min *	Suction Flow rate l/min *	Port size BSP/NPT/SAE	Weight kg **
A03	180	50	1 1/2"	4,2
A06	210	60		
A10	250	80		
A25	310	125		
P10	280	118		
M60-M90	-	130		

* Flow rates with 30 mm²/s fluid viscosity
** Weight including filter element

Thread connections

Type	A	B	C
G1	1 1/2" BSP	1/8" BSP	M10
G2	1 1/2" NPT	1/8" NPT	3/8" UNC
G3	SAE 24 - 1 7/8" - 12 UN	1/8" NPT	3/8" UNC

Suction filter - Housing pressure drop

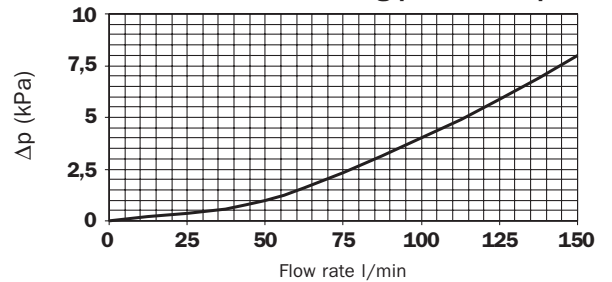

Return line filter - Housing pressure drop

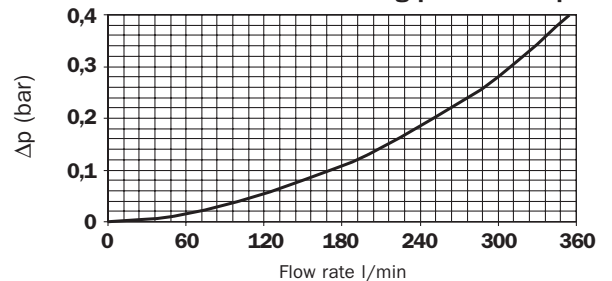

Selection & installation information

Please refer to individual pressure drop curves to obtain filter assembly pressure drop information

The following filter sizing recommendations are based using a mineral oil fluid at 30 mm²/s (cSt) with a maximum total filter assembly (housing and filter element) pressure drop of 30% of the filter condition indicator (0.4 bar) for line and return filter and 8 kPa for suction filter.

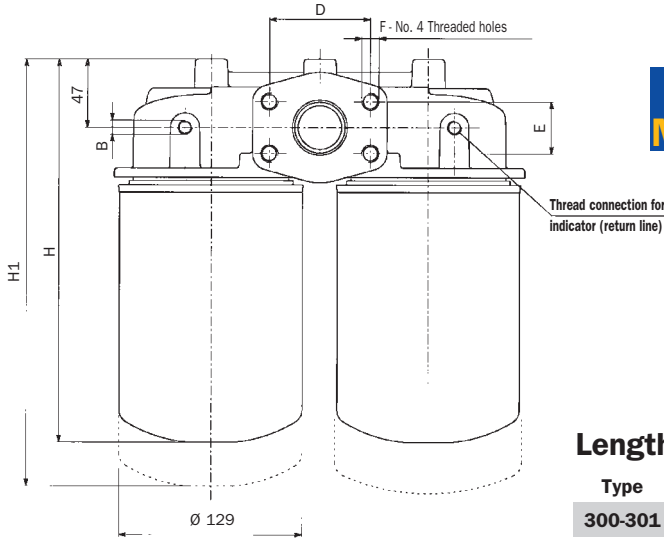

MPS 300-351

Lengths

Type	H	H1
300-301	265	290
350-351	310	335

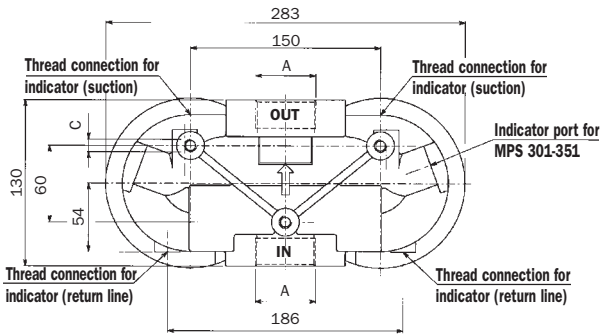

Indicator for suction filter MPS 300-350 (only for option G1-G5-F1)

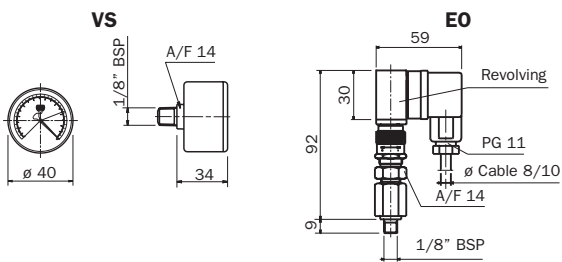

Flange connections

Type	A	B	C	D	E	F
F1	1 1/2" SAE 3000 PSI/M	1/8" BSP	M12	69,85	35,71	M12
F2	1 1/2" SAE 3000 PSI/UNC	1/8" NPT	1/2" UNC	69,85	35,71	1/2" UNC

Indicator for return filter MPS 300-350 (only for option G1-G5-F1)

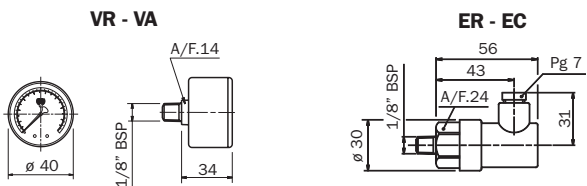

Indicator for line filter MPS 301-351

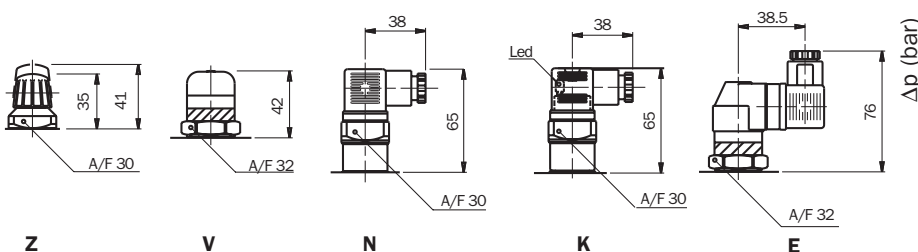

MPS SERIES 300-301 SIZES

Filter assembly	Line Flow rate l/min	Suction Flow rate l/min	Port size BSP/NPT/SAE	Weight kg **
A03	130	30	1 1/2"	5,4
A06	170	45		
A10	220	65		
A25	290	110		
P10	270	100		
M60-M90	-	120		

MPS SERIES 350-351 SIZES

Filter assembly	Line Flow rate l/min	Suction Flow rate l/min	Port size BSP/NPT/SAE	Weight kg **
A03	180	50	1 1/2"	5,6
A06	210	60		
A10	250	80		
A25	310	125		
P10	280	118		
M60-M90	-	130		

* Flow rates with 30 mm²/s fluid viscosity
** Weight including filter element

Thread connections

Type	A	B	C
G1	1 1/2" BSP	1/8" BSP	M10
G2	1 1/2" NPT	1/8" NPT	3/8" UNC
G3	SAE 24 - 1 7/8" - 12 UN	1/8" NPT	3/8" UNC

Suction filter - Housing pressure drop

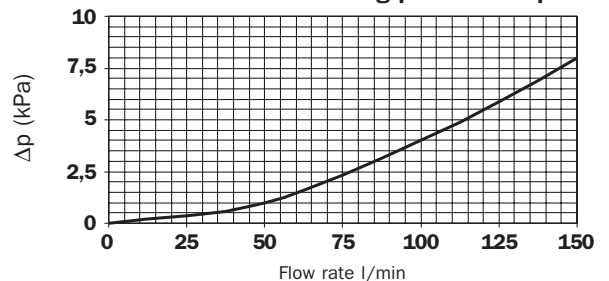

Return line filter - Housing pressure drop

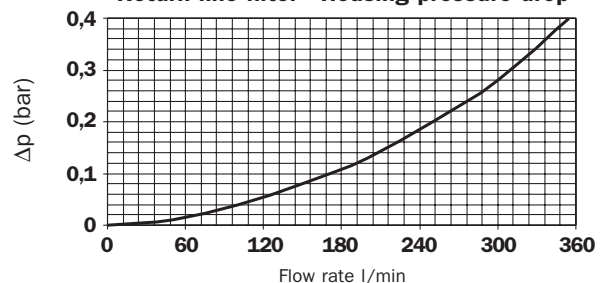

Description

FILTER ELEMENT SERIES -

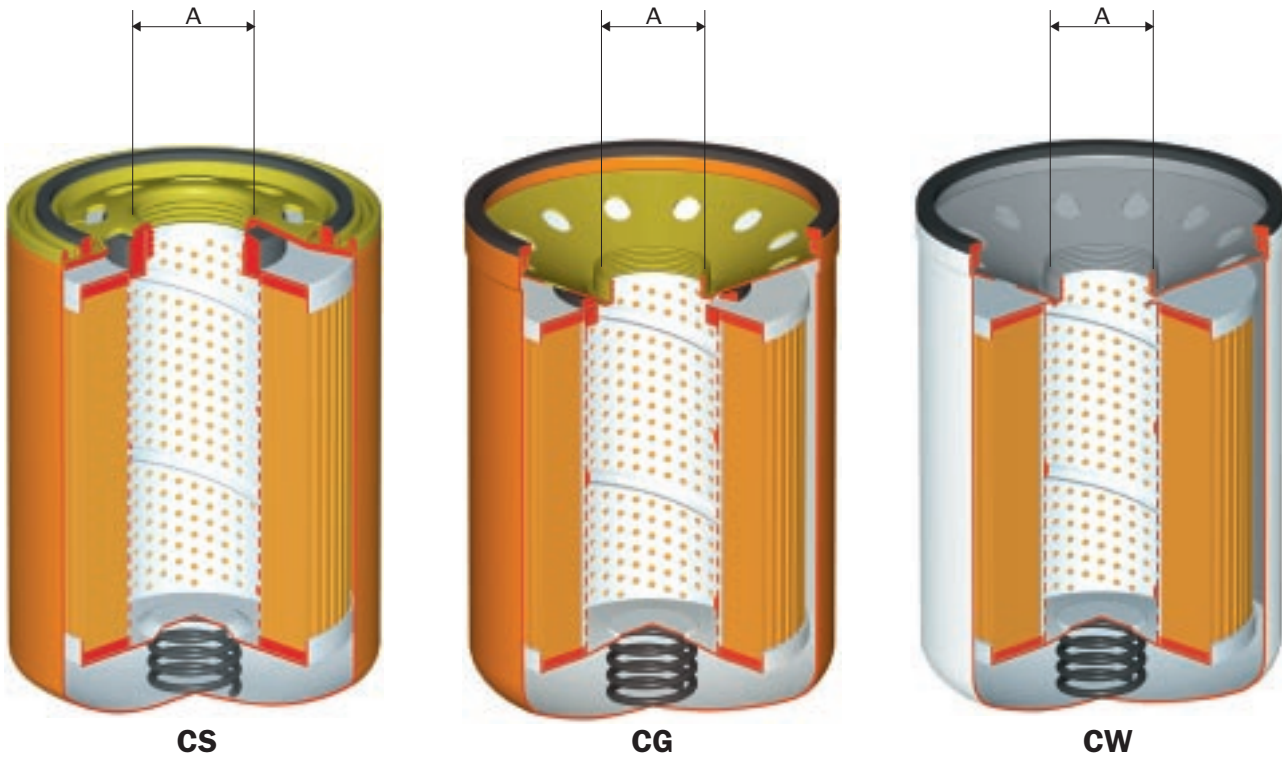

New

absolute filter elements
independently tested
in the following Institutes:

Thread connections

Type	A
CS 050-070	3/4" BSP
CS 100-150	1 1/4" BSP

Type	A
CG 050-070	1" - 12 UN
CG 100-150	1 1/2" - 16 UN

Type	A
CW 050	1" - 12 UN
CW 150	1 1/2" - 16 UN

Institute of Filtration
(France)



Description

MST - Suitable for installation on return lines, mounted tank top where the flow does not exceed 350 l/min. MST use spin-on canisters incorporating a bypass valve. To avoid oil leaks during maintenance, the canisters have a special anti-drain membrane. **MST** - filter is ideal for machine tool and agricultural applications.

New

absolute filter elements
independently tested

in the following Institutes:

Institute of Filtration
(France)

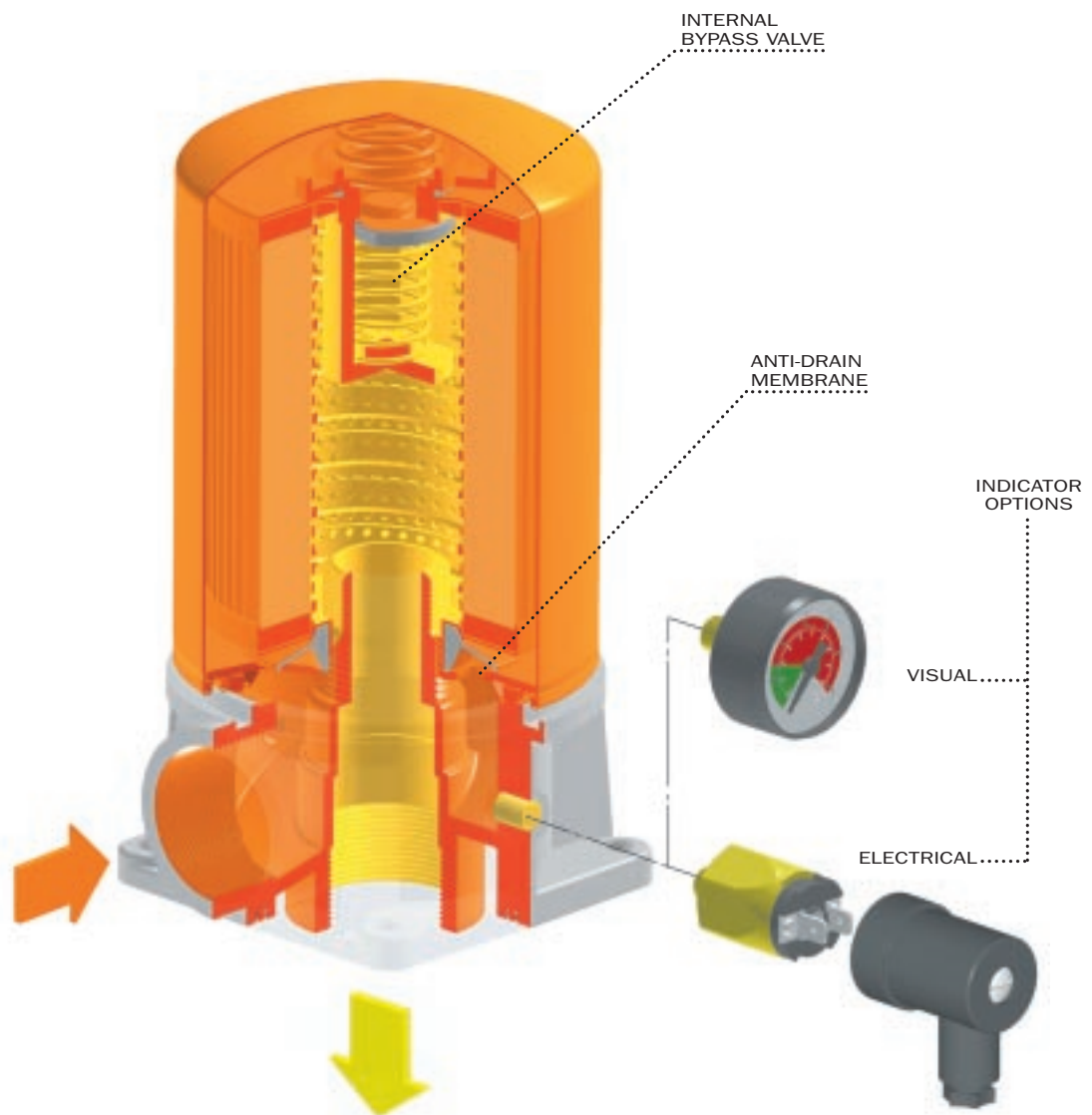

Selection & installation information

Filter elements types

A Series

Absolute inorganic microfibre filtration media, available in 3, 6, 10 and 25 micron
Example - **A03, A06, A10** or **A25**

P Series

Nominal cellulose impregnated paper media, available in 10 and 25 micron.
Example - **P10** or **P25**

M Series

Metal mesh media, available in 25, 60, and 90 micron.
Example - **M25, M60** or **M90**.

Please refer to individual pressure drop curves to obtain filter assembly pressure drop information

The following filter sizing recommendations are based using a mineral oil fluid at 30 mm²/s (cSt) with a maximum total filter assembly (housing and filter element) pressure drop of 30% of the filter condition indicator (0.4 bar) for line and return filter.

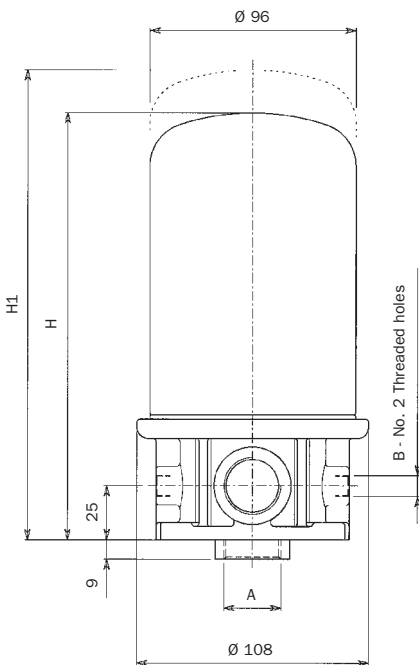
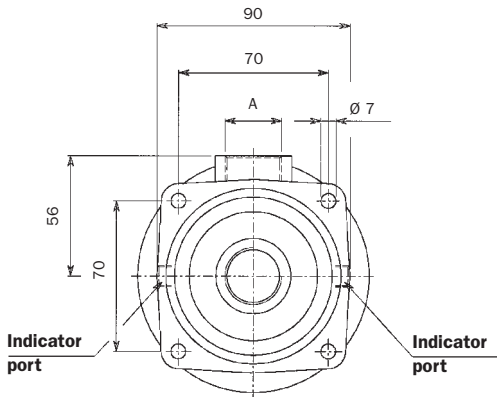

Indicator (only for option G1)

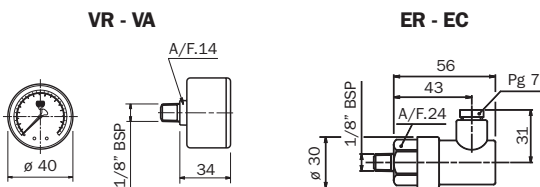

MST SERIES 050 SIZES

MST 050-070

Filter assembly	Flow rate l/min *	Port size BSP/NPT/SAE	Weight kg **
A03	42	3/4"	1,2
A06	50		
A10	65		
A25	75		
P10	68		

MST SERIES 070 SIZES

Filter assembly	Flow rate l/min *	Port size BSP/NPT/SAE	Weight kg **
A03	55	3/4"	1,5
A06	60		
A10	68		
A25	80		
P10	76		

* Flow rates with 30 mm²/s fluid viscosity
** Weight including filter element

Thread connections

Type	A	B
G1	3/4" BSP	1/8" BSP
G2	3/4" NPT	1/8" NPT
G3	SAE 8 - 3/4" - 16 UN	1/8" NPT

Lengths

Type	H	H1
050	190	208
070	265	283

Housing pressure drop

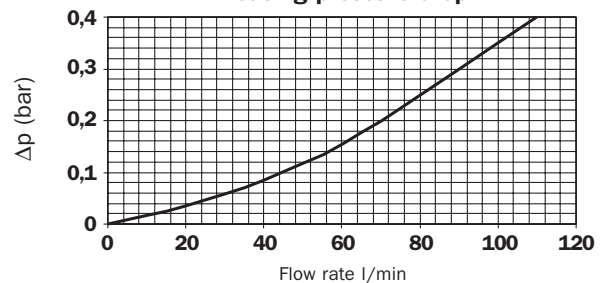

Selection & installation information

Please refer to individual pressure drop curves to obtain filter assembly pressure drop information

The following filter sizing recommendations are based using a mineral oil fluid at 30 mm²/s (cSt) with a maximum total filter assembly (housing and filter element) pressure drop of 30% of the filter condition indicator (0.4 bar) for line and return filter.

MST 100-150

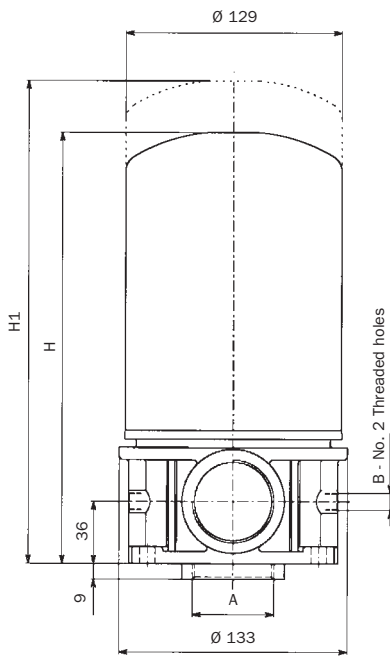
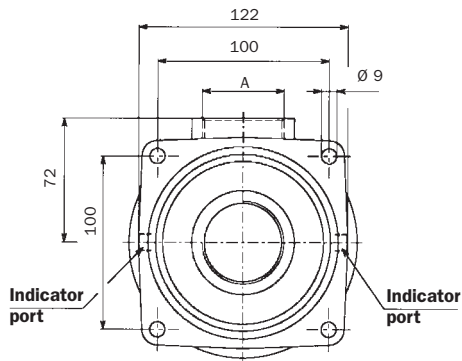

Indicator (only for option G1)

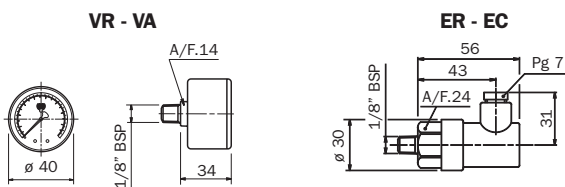

MST SERIES 100 SIZES

Filter assembly	Flow rate l/min *	Port size BSP/NPT/SAE	Weight kg **
A03	80	1 1/2"	2,3
A06	90		
A10	125		
A25	185		
P10	175		

MST SERIES 150 SIZES

Filter assembly	Flow rate l/min *	Port size BSP/NPT/SAE	Weight kg **
A03	90	1 1/2"	2,4
A06	110		
A10	140		
A25	210		
P10	190		

* Flow rates with 30 mm²/s fluid viscosity
** Weight including filter element

Thread connections

Type	A	B
G1	1 1/2" BSP	1/8" BSP
G2	1 1/2" NPT	1/8" NPT
G3	SAE 20 - 1 5/8" - 12 UN	1/8" NPT

Lengths

Type	H	H1
100	250	275
150	280	305

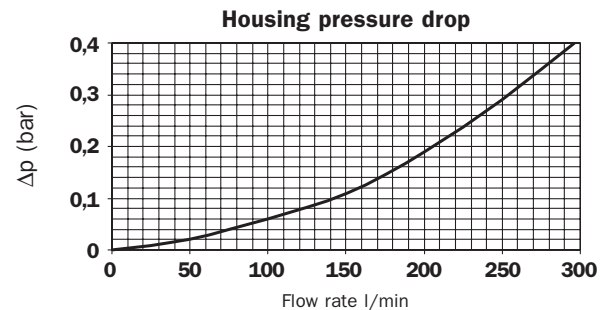

Pressure drop information

General

Pressure drop versus flow rate curve information for both housing and filter elements is in accordance with ISO 3968

Filter assembly pressure drop - $\Delta p_{\text{Total}} = \Delta p_{\text{Housing}} + \Delta p_{\text{Filter element}}$

Housing pressure drop - The housing pressure drop is proportional to the fluid density

Filter element pressure drop - Filter element pressure drop is proportional to kinematic viscosity therefore always check the fluid operating temperature and fluid type to obtain the working viscosity according to the following formula:

$$\Delta p_1 \text{ Filter element} = (\text{working viscosity} / \text{brochure viscosity}) \times \Delta p \text{ filter element}$$

Brochure viscosity 30 mm²/s (cSt)

$$1 \text{ kPa} = 0,01 \text{ bar}$$

Filter assembly sizing example

- Customer requires a 100 l/min filter assembly
- Mineral oil fluid: ISO VG46 (46 mm²/s (cSt) at 40°C)
- 25 micron absolute filtration
- return line application

Selection :

- **Housing pressure drop** - MPS 100/101 with 100 l/min $\Delta p = 0,13 \text{ bar}$ (see curve on page 8)
- **Filter element pressure drop** brochure viscosity - CS 100A25 with 100 l/min $\Delta p = 0,09 \text{ bar}$ (see curve on page 17)
- **Filter element pressure drop** working viscosity - With 46 mm²/s (cSt) $\Delta p_1 = 0,09 \times (46/30) = 0,138 \text{ bar}$
- **Filter assembly pressure drop** $\Delta p_{\text{Total}} = \Delta p_{\text{Housing}} + \Delta p_1 \text{ Filter element} = 0,13 + 0,138 = \mathbf{0,268 \text{ bar}^*}$ { Acceptable pressure drop value, as per our recommendations

Bypass valves pressure drop

The curves were obtained using a mineral oil with a density of 0,86 kg/dm³.
The Δp varies proportionally to the density.

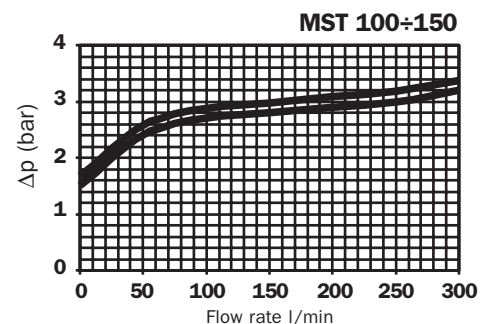
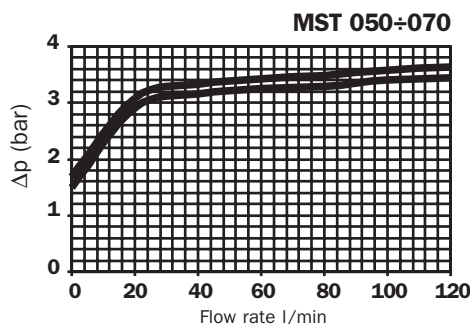
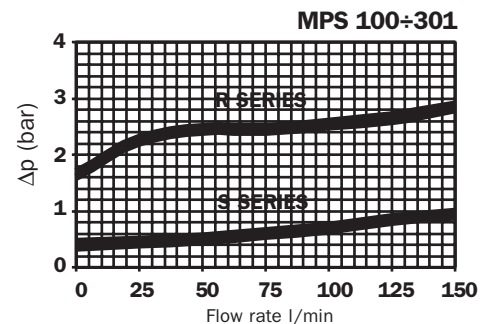
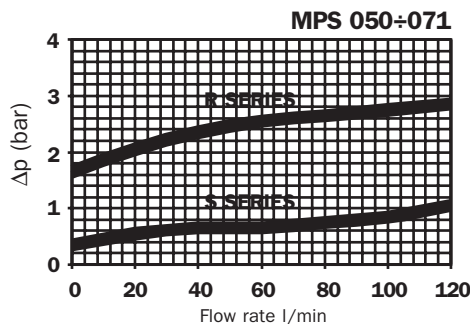

R series: Return filter
S series: Suction filter

SUCTION FILTER

Filter elements - P/M Series

The curves were obtained using a mineral oil with a kinematic viscosity of 30 mm²/s (cSt).
The Δp varies proportionally to the fluid kinematic viscosity.

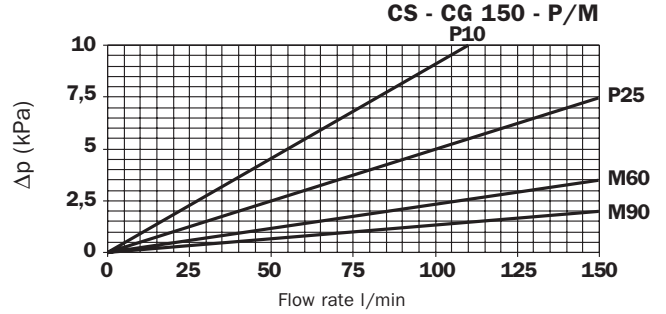
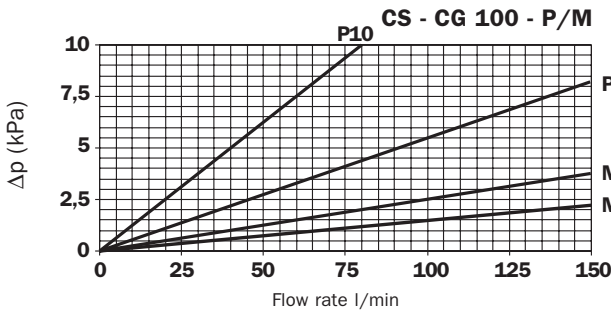
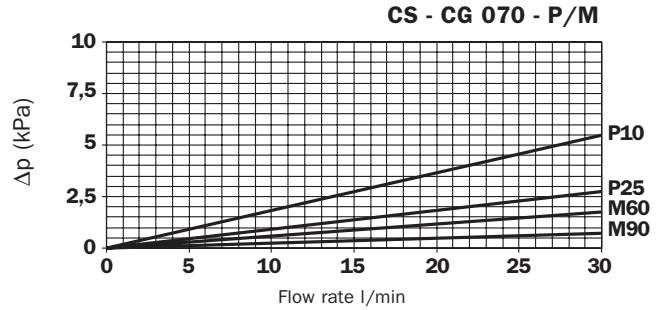
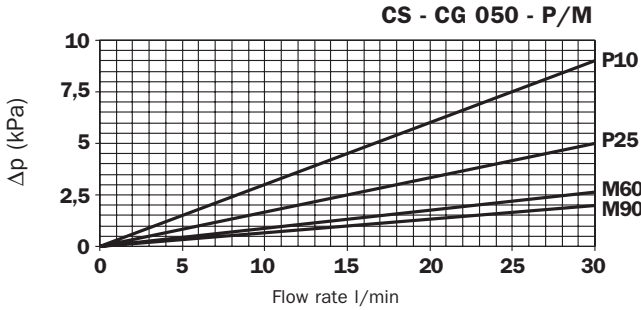

Filter elements - A Series

The curves were obtained using a mineral oil with a kinematic viscosity of 30 mm²/s (cSt).
The Δp varies proportionally to the fluid kinematic viscosity.

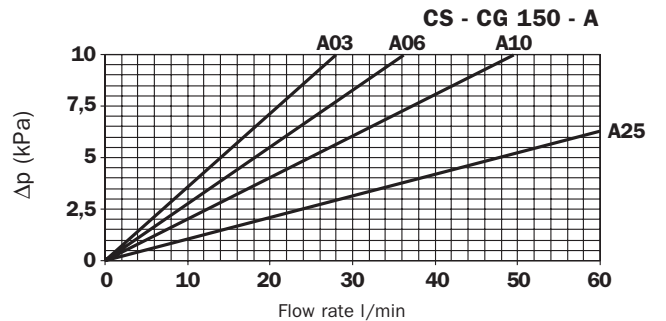
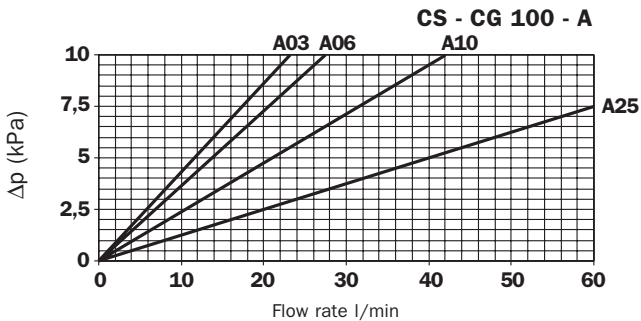
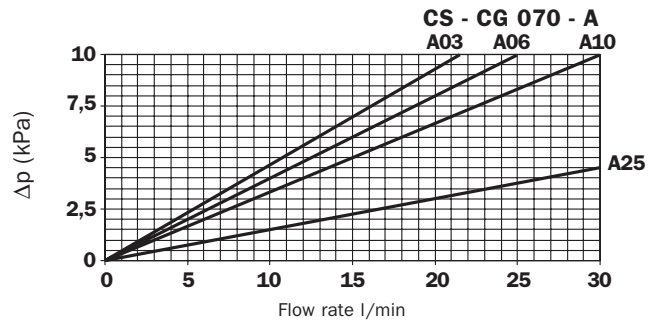
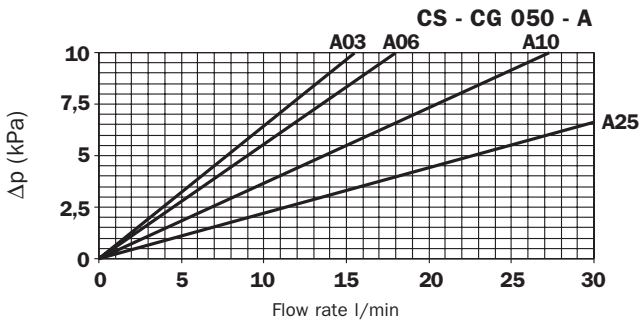

RETURN FILTER

Filter elements - P/M Series

The curves were obtained using a mineral oil with a kinematic viscosity of $30 \text{ mm}^2/\text{s}$ (cSt).
The Δp varies proportionally to the fluid kinematic viscosity.

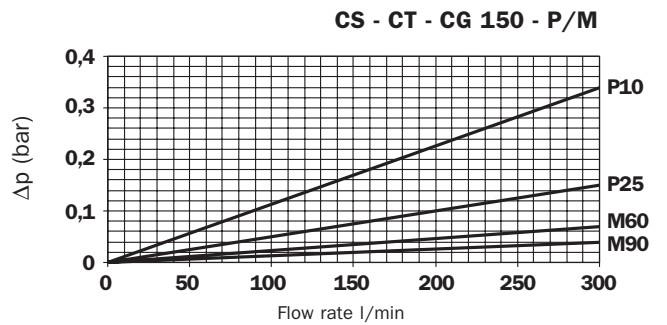
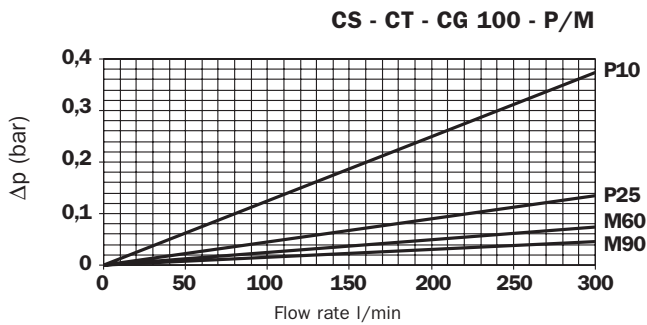
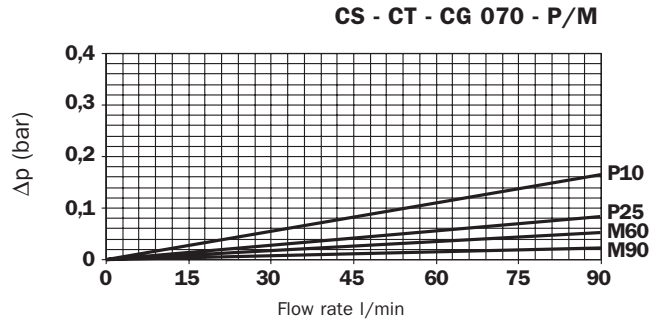
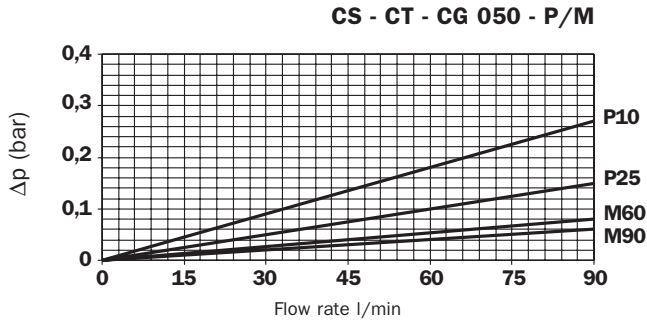

Filter elements - A Series

The curves were obtained using a mineral oil with a kinematic viscosity of $30 \text{ mm}^2/\text{s}$ (cSt).
The Δp varies proportionally to the fluid kinematic viscosity.

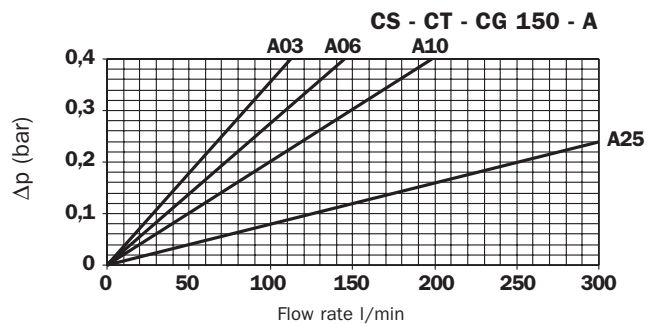
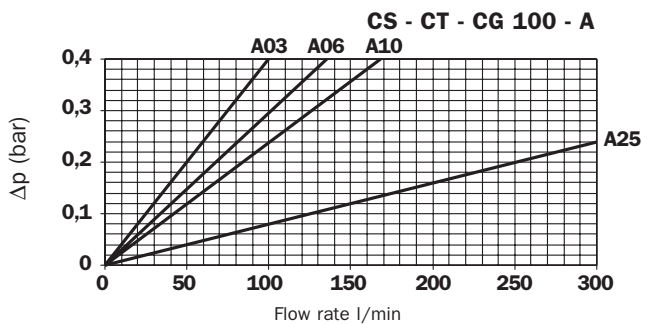
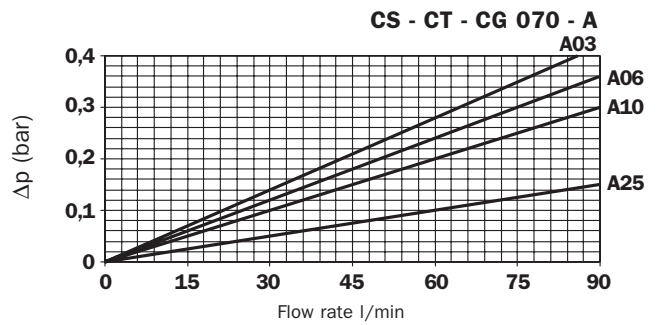
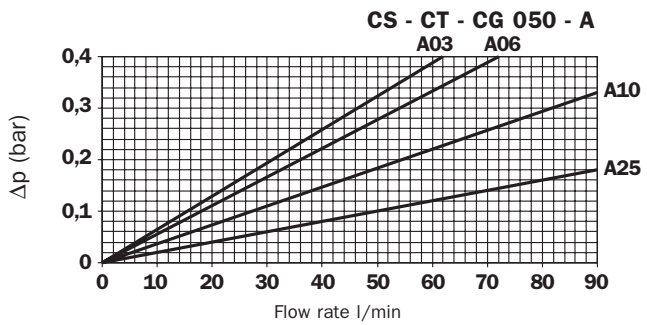

Ordering information

MPS

Nominal sizes

Series 0	Series 1
050	051
070	071
100	101
150	151
200	-
250	-
300	301
350	351

Bypass valve

Filter series "0"	
C	With bypass 1,75 bar - 4 indicator ports
O	Without bypass with indicator ports on suction
P	Without bypass with indicator ports on return
R	with bypass 1,75 bar and indicator ports on return
S	With bypass 30 kPa and indicator ports on suction
U	Without bypass without indicator ports
Filter series "1"	
R	With bypass 1.75 bar
P	Without bypass

Port options

Type	MPS 050-071	MPS 100-151	MPS 200-250	MPS 300-351
G1	3/4" BSP	1 1/4" BSP	1 1/2" BSP	1 1/2" BSP
G2	3/4" NPT	1 1/4" NPT	1 1/2" NPT	1 1/2" NPT
G3	SAE 12	SAE 20	SAE 24	SAE 24
G4	SAE 8	-	-	-
G5	1" BSP	-	-	-
G6	1" NPT	-	-	-
F1	-	-	-	1 1/2" SAE 3000 Psi/M
F2	-	-	-	1 1/2" SAE 3000 Psi/UNC

G4 Option without bypass only

Series

CS	European std. filter element
CG	USA standard filter element
CW	USA standard filter element (water removal type)

Filter condition indicator

S	With threaded hole only
T	With plug
Indicators for suction filters (MPS series only)	
VS	Visual vacuum gauge
EO	Electrical vacuum switch exchange contact
Indicators for return filters (for MPS/MST series)	
VA	Visual pressure gauge
VR	Colour coded pressure gauge
ER	Pressure switch with N.O. contacts
EC	Pressure switch with N.C. contacts
Differential Indicators for line filters (only for series "1")	
S	With threaded hole only
T2	Plug for indicator port
1V	Visual 1,2 bar
V6	Visual 2 bar
Z1	Visual 1,2 bar
Z6	Visual 2 bar
N1	Electrical 1,2 bar
N6	Electrical 2 bar
1E	Visual-electrical 1,2 bar
E6	Visual-electrical 2 bar
K1*	Visual-Electrical 1,2 bar
K6*	Visual-Electrical 2 bar

*For K visual-electrical indicator, specify the voltage (f.i. K61)

Seals

A	Nitrile (Buna - N)
V	Viton

Filter elements M/P series

P10	Resin-impregnated paper $\beta_x \geq 2$
P25	
M25	Square wire mesh
M60	
M90	
Filter elements A series	
A03	Inorganic microfibre $\beta_x \geq 200$
A06	
A10	
A25	

Nominal sizes

050	no. 1 element for MPS 050-051
070	no. 1 element for MPS 070-071
100	no. 1 element for MPS 100-101
100	no. 2 elements for MPS 200
100	no. 2 elements for MPS 300-301
150	no. 1 element for MPS 150-151
150	nr. 2 elements for MPS 250
150	nr. 2 elements for MPS 300-301

CS

Replacement element

MP Filtri - Filtration products will only be guaranteed if original MP Filtri replacement elements and spares are used

Data held in this publication is given only for indicative purposes. MP Filtri reserves to introduce modifications to described items for technical or commercial reasons. Copyright reserved.

MST

Nominal sizes

050
070
100
150

Seals

A Nitrile (Buna - N)
V Viton

Port options

Type	MST 050-070	MST 100-150
G1	3/4" BSP	1 1/2" BSP
G2	3/4" NPT	1 1/2" NPT
G3	SAE 8	SAE 20

Filter elements indicator

S With threaded hole only
T With plug
VR Colour coded pressure gauge
ER Pressure switch with N.O. contacts
EC Pressure switch with N.C. contacts

Bypass valve

B Calibration: 1,75 bar

Seals

A Nitrile (Buna - N)
V Viton

Filter elements M/P series

P10
P25 Resin-impregnated paper $\beta_x \geq 2$
M25
M60
M90 Square wire mesh

Filter elements A series

A03
A06
A10
A25 Inorganic microfibre $\beta_x \geq 200$

CT

Replacement element

MP Filtri - Filtration products will only be guaranteed if original MP Filtri replacement elements and spares are used

Data held in this publication is given only for indicative purposes. MP Filtri reserves to introduce modifications to described items for technical or commercial reasons. Copyright reserved.



Head Quarter :

MP FILTRI S.p.A. Italy

Via Matteotti, 2
20060 Pessano con Bornago (Milano) Italy
Tel. ++39.02/95703.1
Fax ++39.02/95741497-95740188
email: sales@mpfiltri.com
<http://www.mpfiltri.com>

GREAT BRITAIN

MP FILTRI U.K. Ltd.

Bourton Industrial Park
Bourton on the Water
Gloucestershire GL54 2HQ UK
Phone: 01451-822522
Fax: 01451-822282
email: sales@mpfiltri.co.uk
<http://www.mpfiltri.co.uk>



GERMANY

MP FILTRI D GmbH

Am Wasserturm 5
D-66265 Heusweiler/Holz
Phone: 06806/85022-0
Fax: 06806/85022-18
email: mpfiltrink@aol.com

FRANCE

MP FILTRI FRANCE

B.P. 325
01603 Trevoux Cedex
Tel: 04.74.08.84.78
Telefax: 04.74.08.80.45
email: mpfiltrifrance@wanadoo.fr

USA

MP FILTRI USA Inc.

2055 Quaker Pointe Drive
Quakertown, PA 18951
Phone: 215-529-1300
Fax: 215-529-1902
email: mpusasales@aol.com
<http://www.mpfiltriusa.com>

CANADA

MP FILTRI CANADA Inc.

210 Jacob Keffer Parkway Concord,
Ontario Canada L4K 4W3
Phone: 905-303-1369
Fax: 905-303-7256
email: mail@mpfiltricanada.com
<http://www.mpfiltricanada.com>